

# SUAS Mendrisio

SUPSI University of Applied Science Mendrisio



Site





“Zone M”





Industrial Nature of the Site





Industrial Nature of the Site





# Organigram

## Research Institute

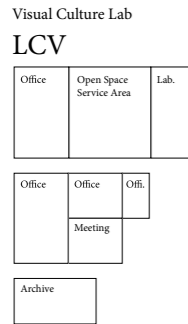

## Maintenance

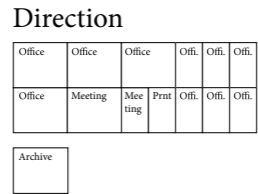

## Bachelor / Master

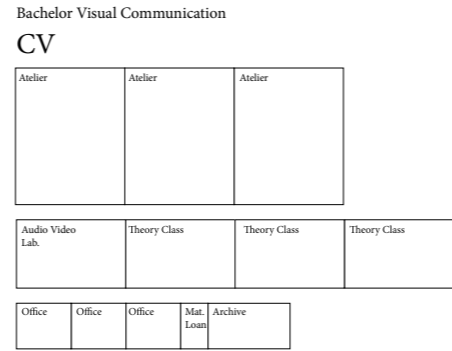

## Institute of Applied Sciences for Built Environment

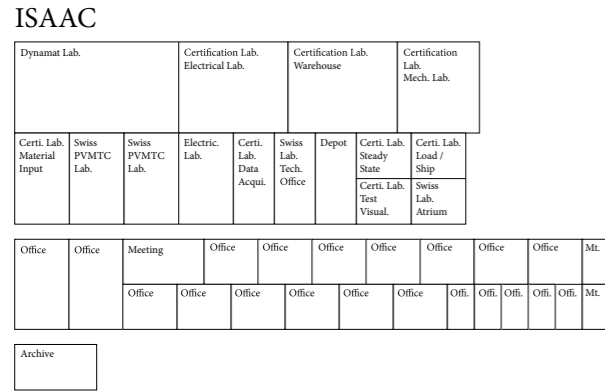

## Institute of Material and Construction

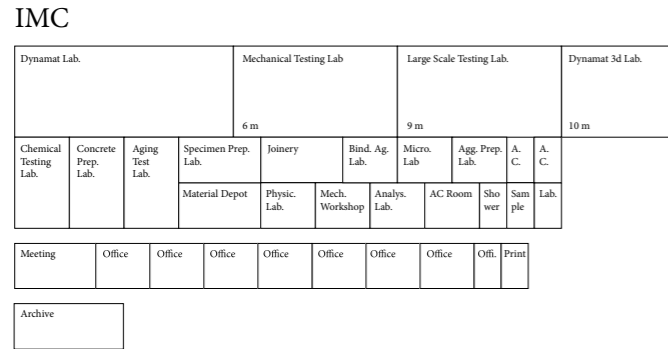

## Institute of Earth Sciences

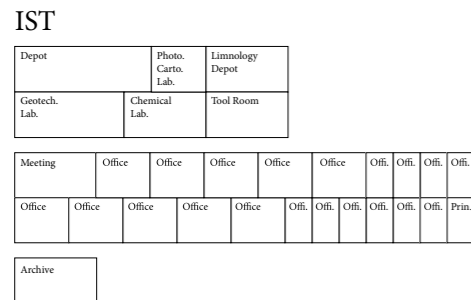

## Bachelor Architecture

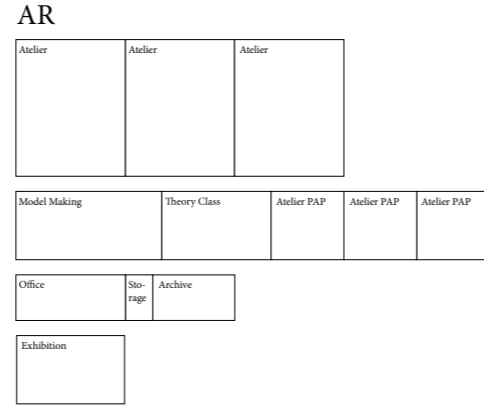

## Bachelor & Master Conservation and Restoration

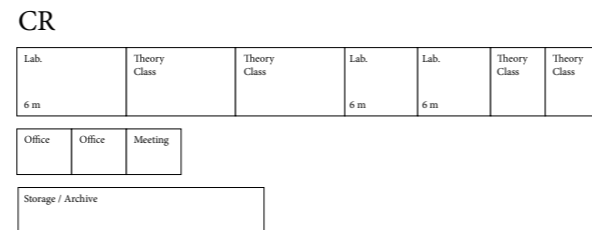

## Bachelor Civil Engineering

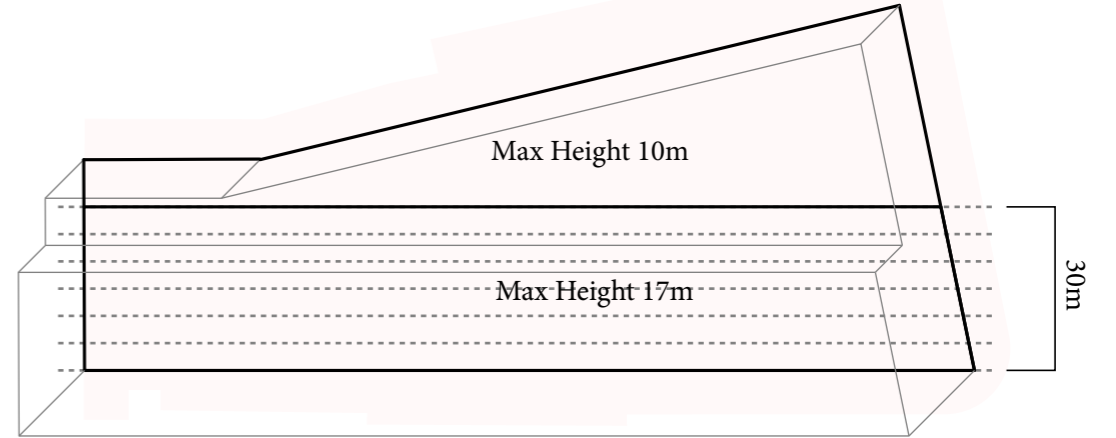
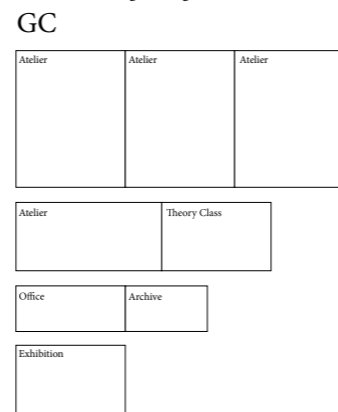

## Common Areas

### Bachelor

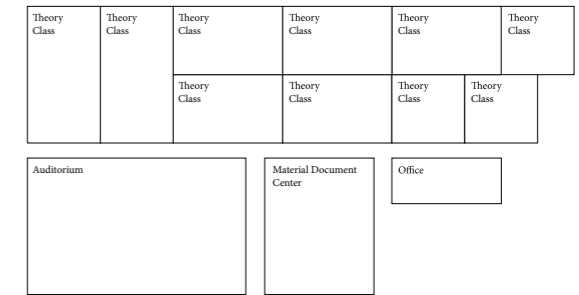

### Master

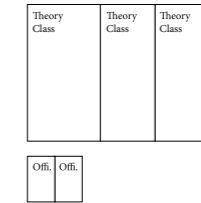

### Weiterbildung

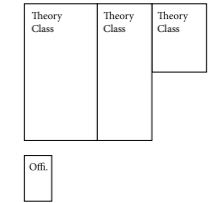

### Public

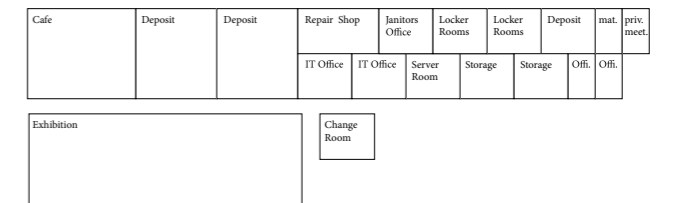

### Library



### Mensa





# Organigram - Scale and Hierarchy

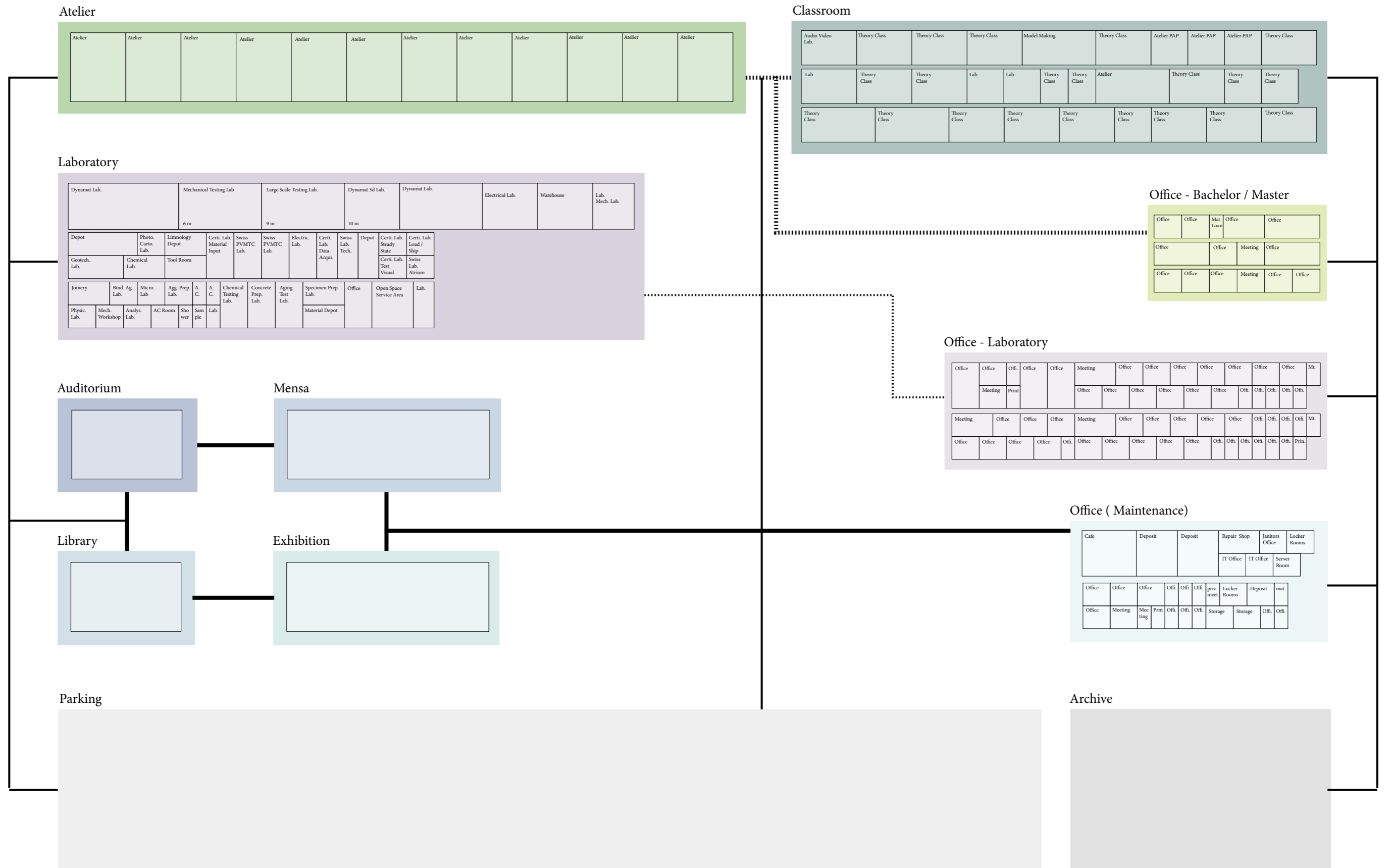

public circulation
  bachelor / master
  research institute



**Organigram - Space Circulations**

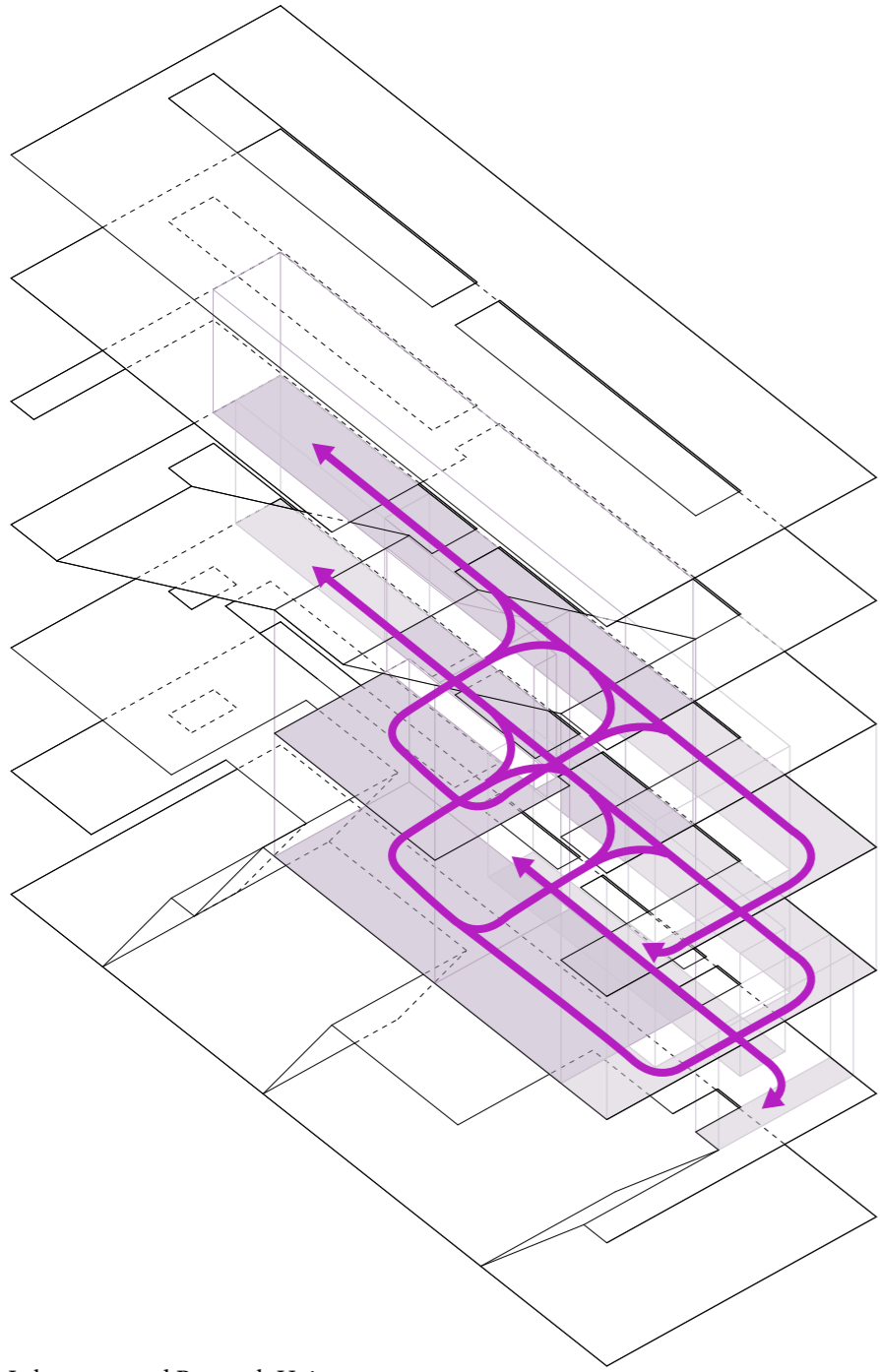

Laboratory and Research Units

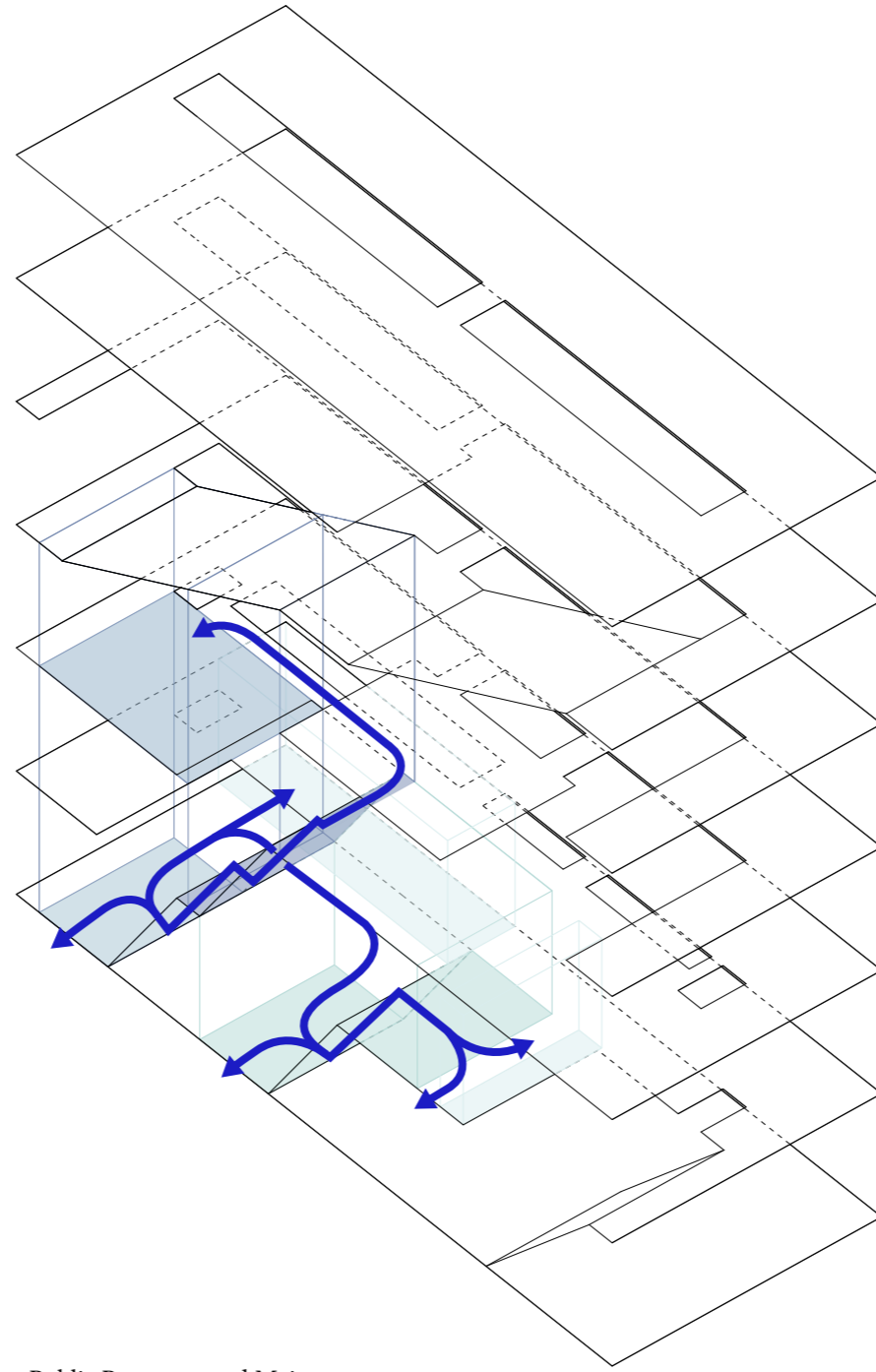

Public Programs and Maintenance

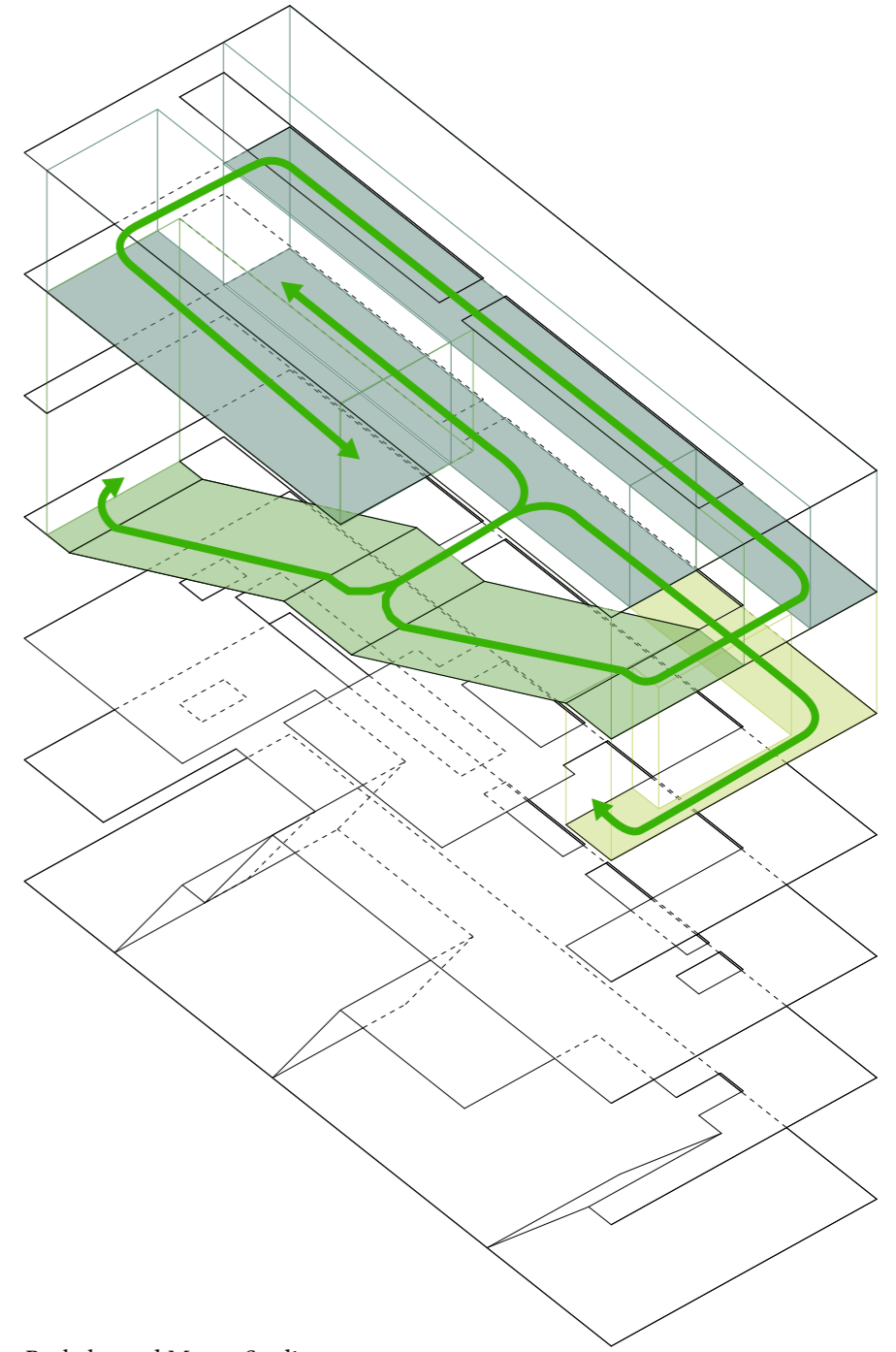

Bachelor and Master Studies



Organigram - Space Circulations

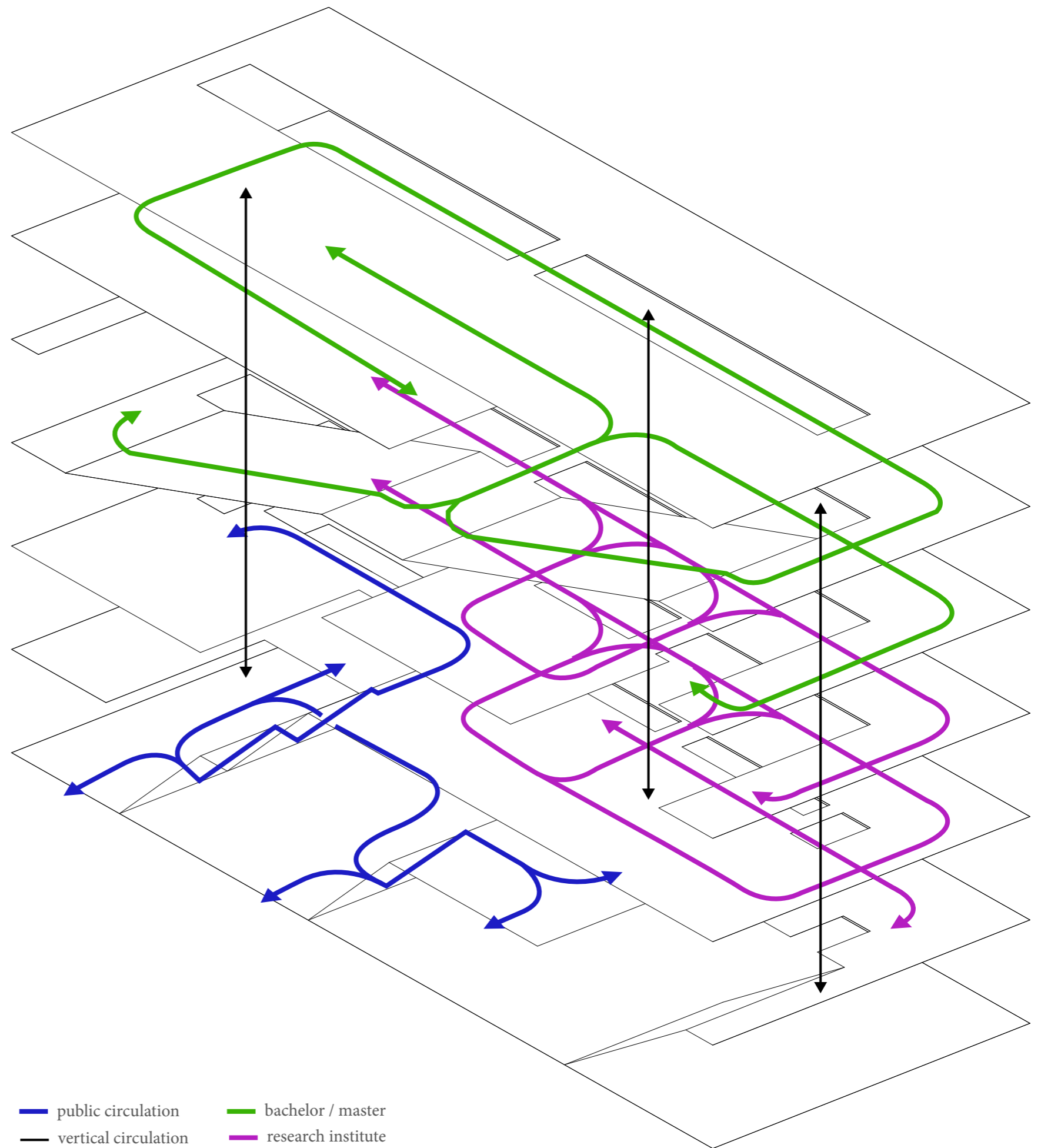

- public circulation
- vertical circulation
- bachelor / master
- research institute



**Plan - Underground (- 4.5 m)**

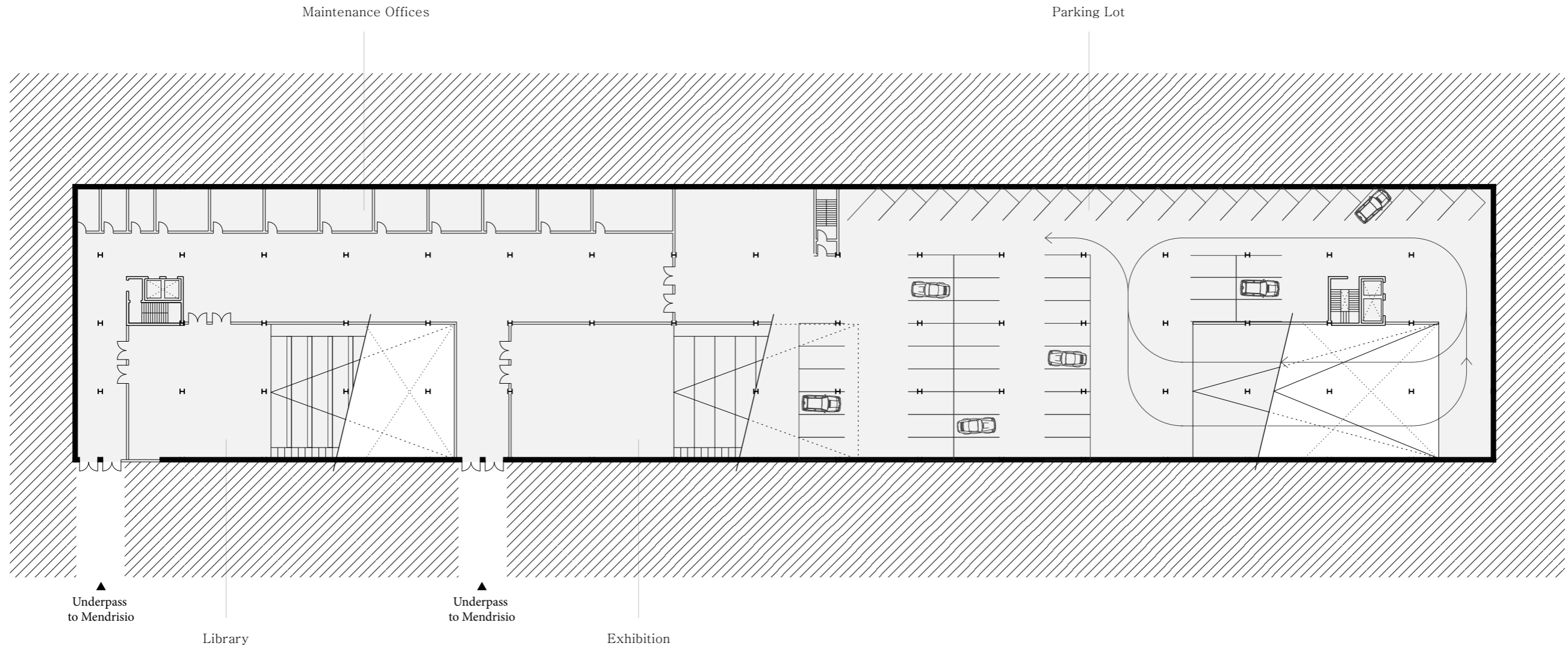

0

20m





**Plan - Ground Floor (0 m)**

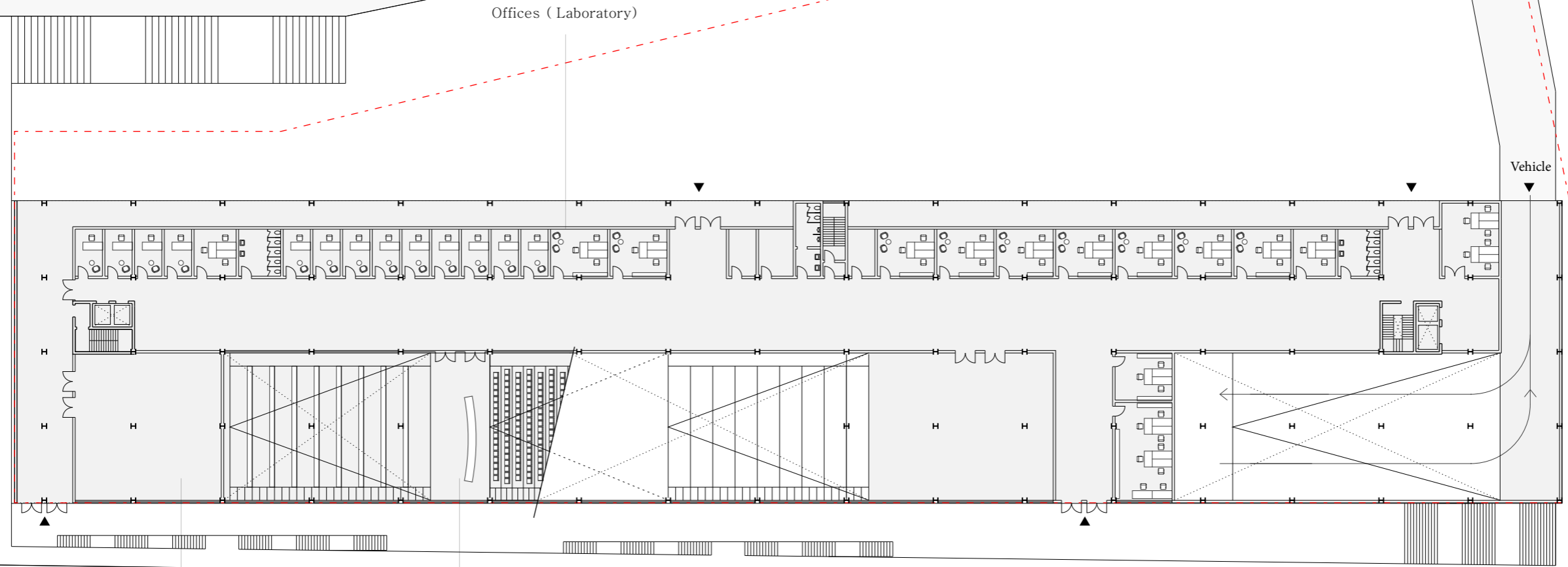

Library

Auditorium

Vehicle

0 20m





**Plan - 1st Floor ( 4.5 m )**

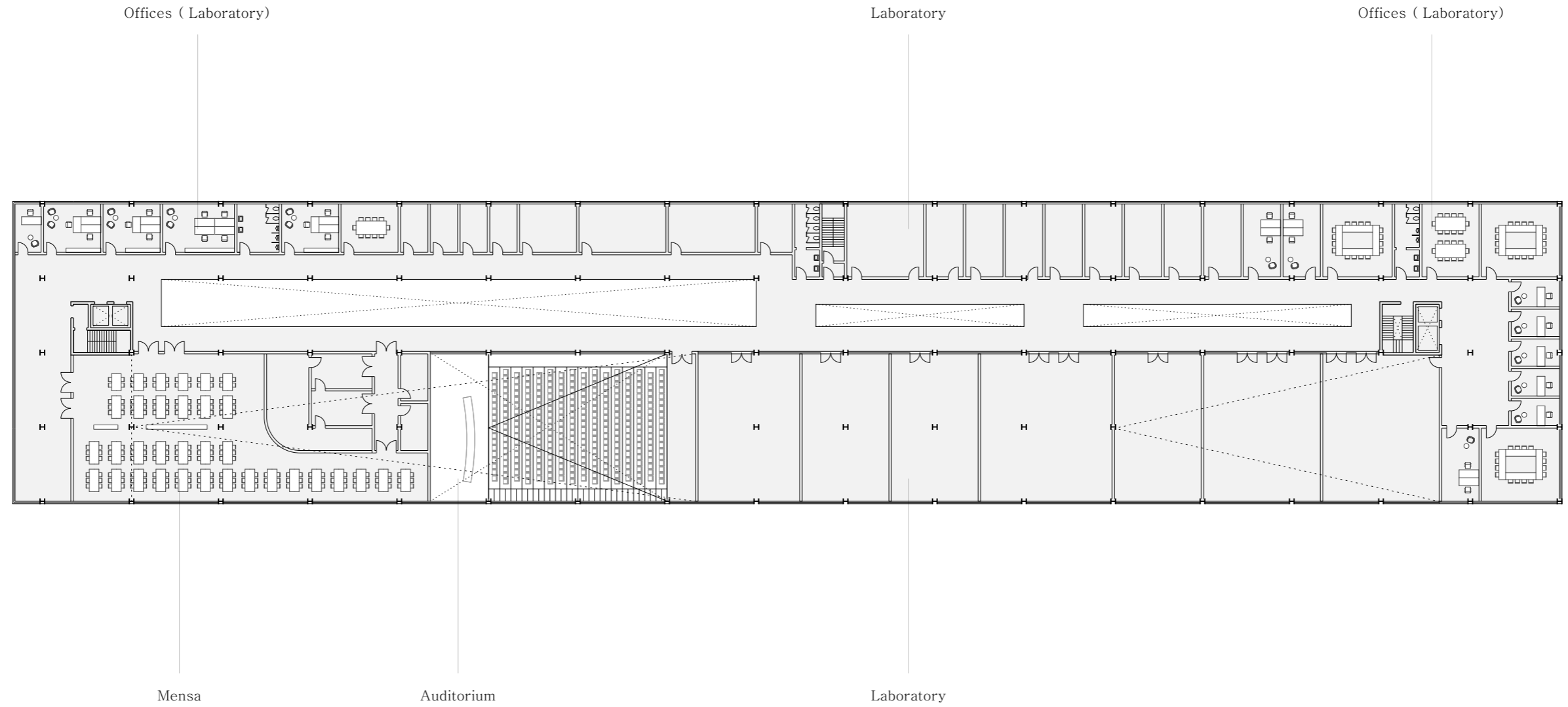



Plan - 2nd Floor (9 m)

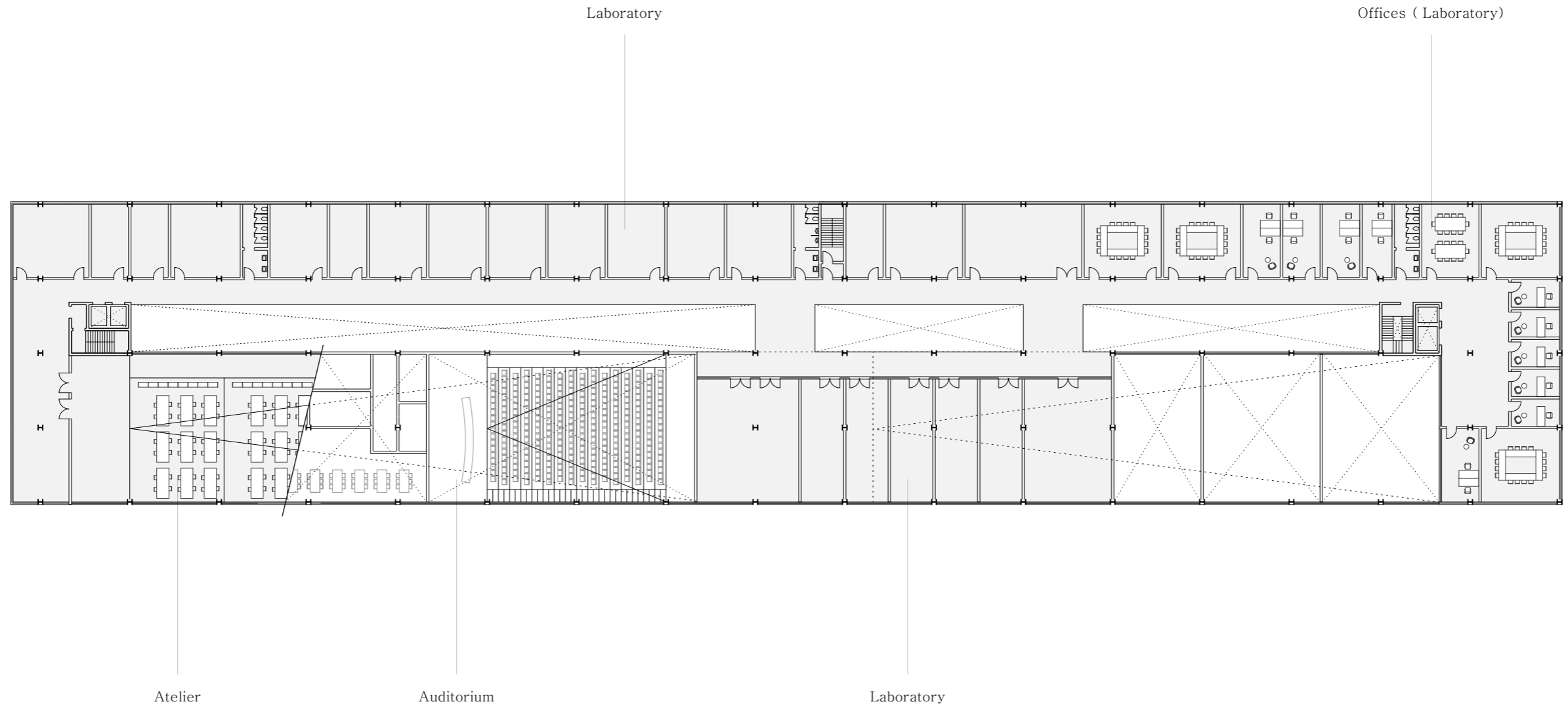



**Plan - 3rd Floor ( 13.5 m )**

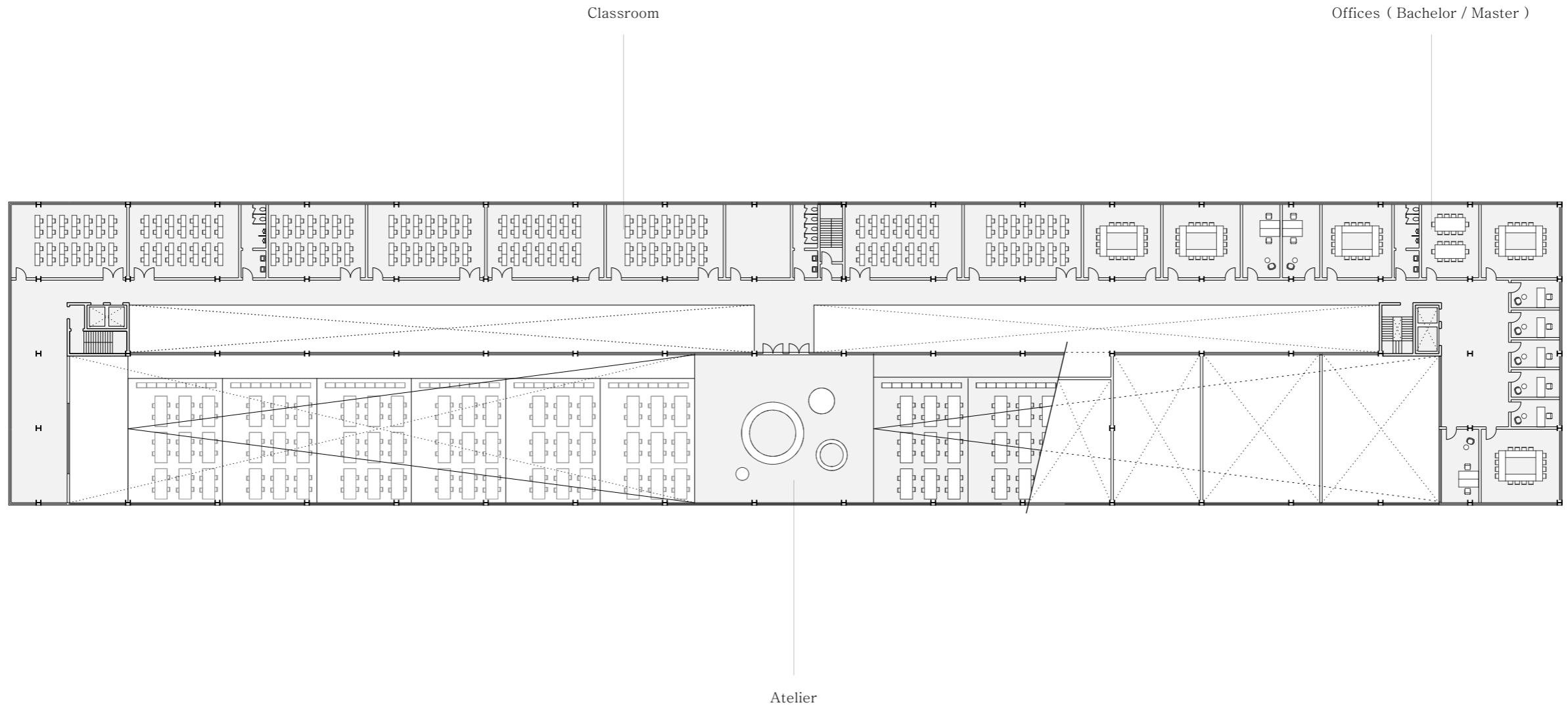



**Plan - 4th Floor ( 17 m)**

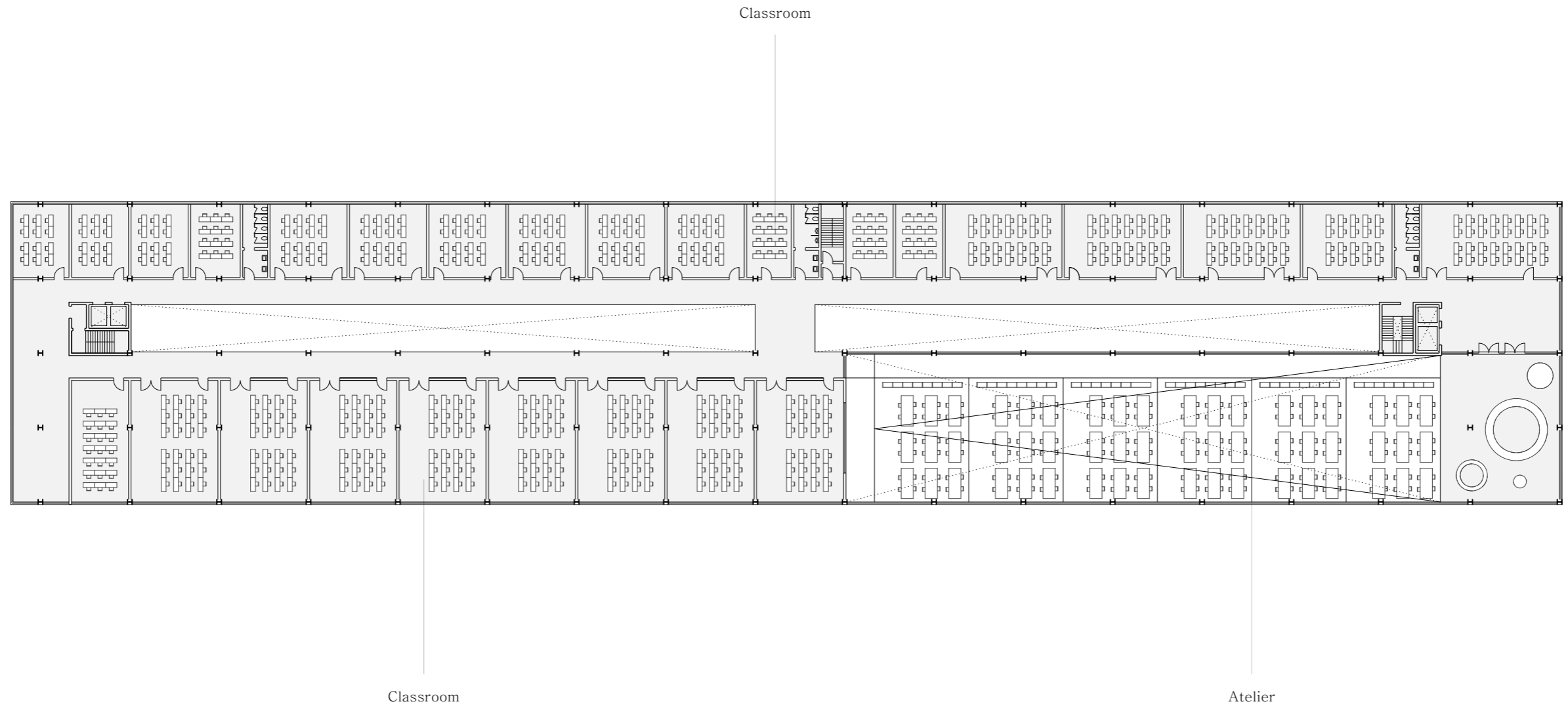













0

20m





# Horizontal Zoning

- |   |                        |   |                              |
|---|------------------------|---|------------------------------|
|  | Auditorium             |  | Classroom                    |
|  | Mensa                  |  | Atelier                      |
|  | Library                |  | Office ( Bachelor / Master ) |
|  | Exhibition             |  | Laboratory                   |
|  | Office ( Maintenance ) |  | Office ( Laboratory )        |
|  | Parking                |   |                              |
|  | Archive                |   |                              |

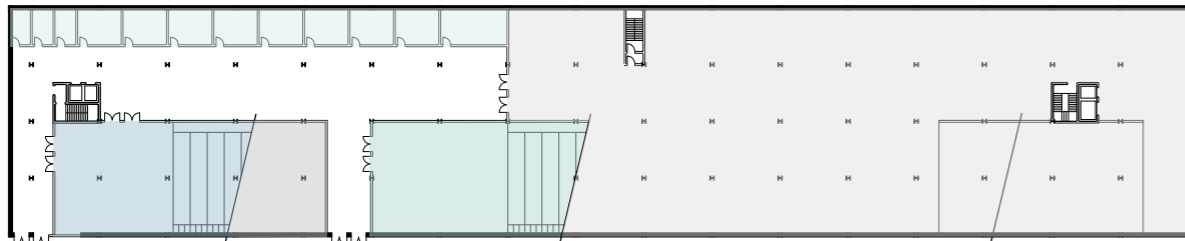

Underground

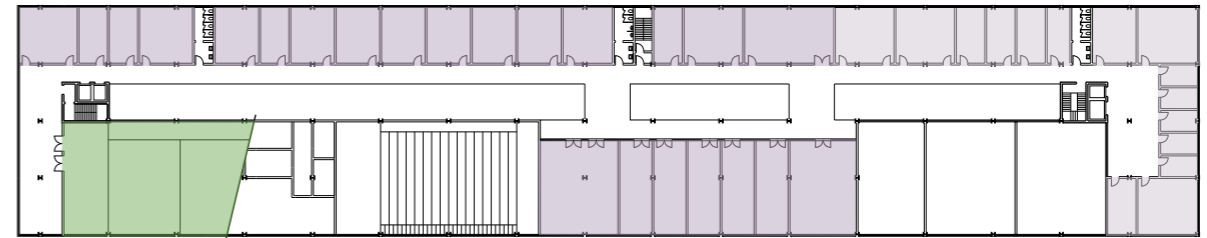

2nd Floor

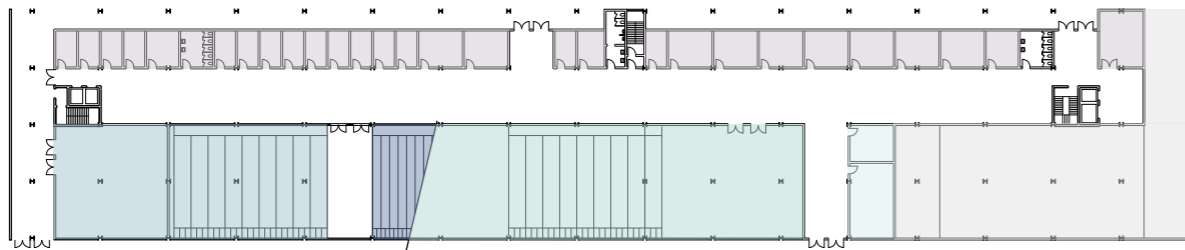

Ground Floor

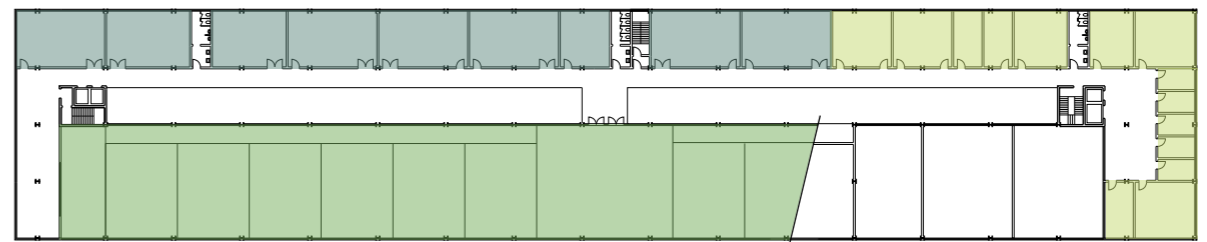

3rd Floor

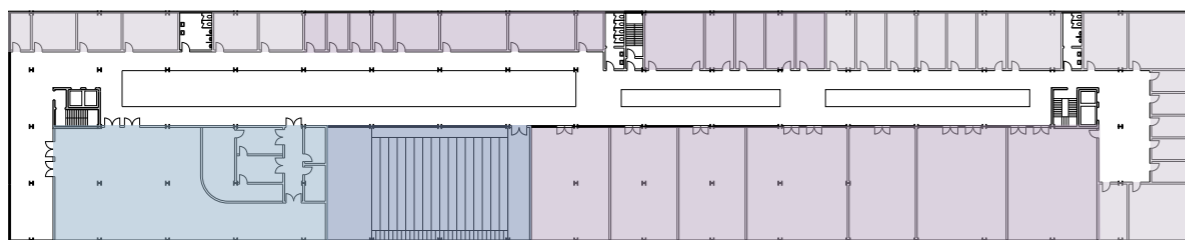

1st Floor

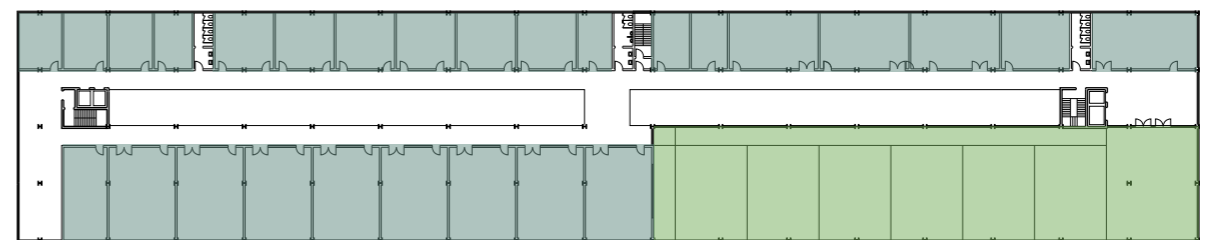

4th Floor



North West Facade



|  
0

|  
20m



**South East Facade**

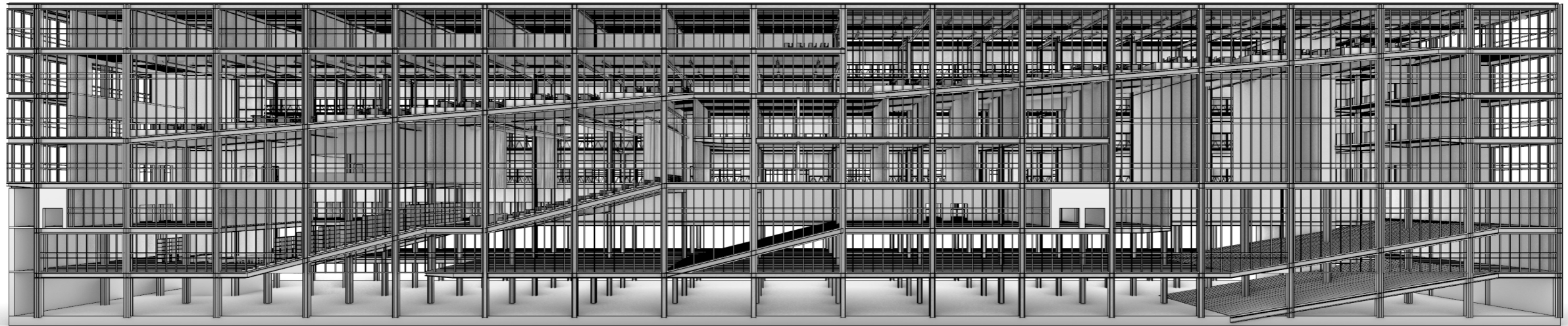

|  
0

|  
20m





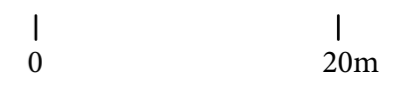
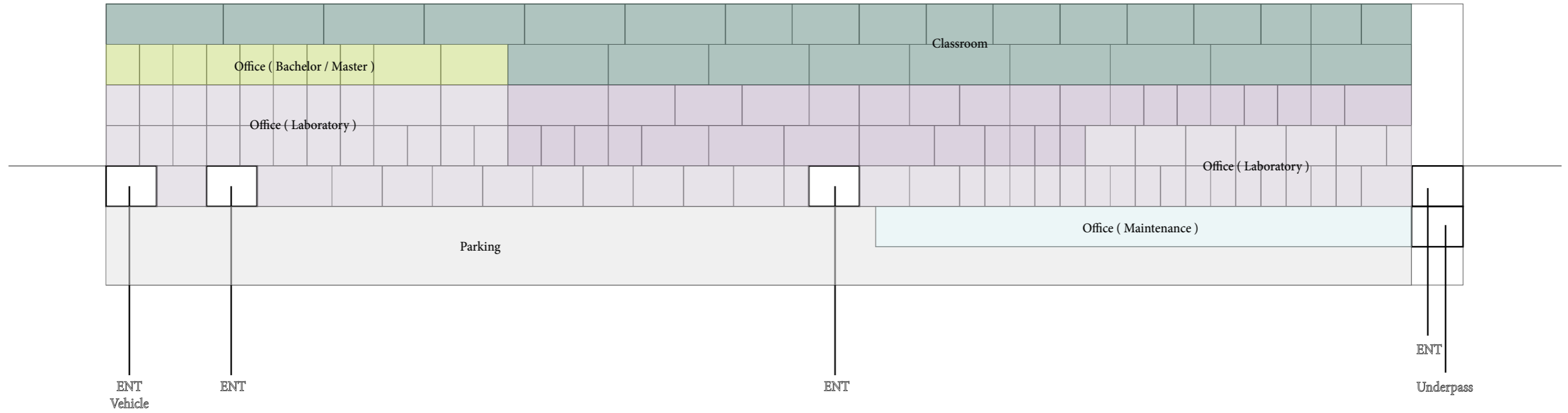
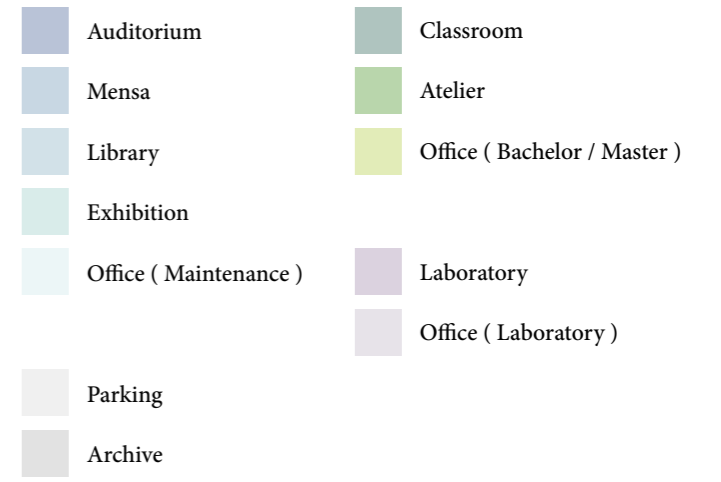









Vertical Zoning ( NW )





**Vertical Zoning ( SE )**

- |  |  |
|--|--|
|  Auditorium             |  Classroom                    |
|  Mensa                  |  Atelier                      |
|  Library                |  Office ( Bachelor / Master ) |
|  Exhibition             |  Laboratory                   |
|  Office ( Maintenance ) |  Office ( Laboratory )        |
|  Parking                |  |
|  Archive                |  |

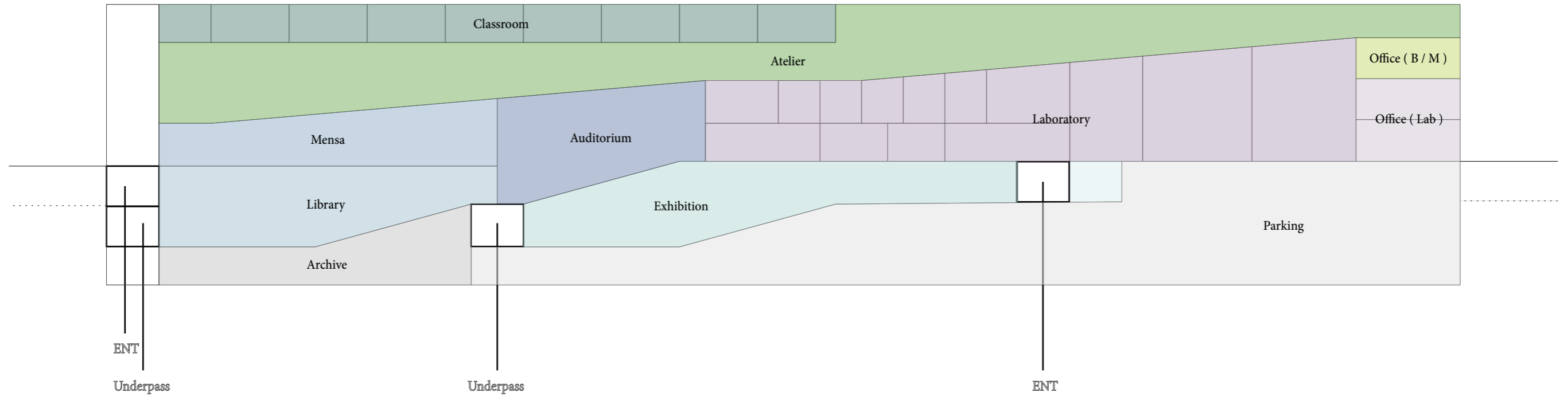

0 | 20m

Interior Facades seen from the Atrium

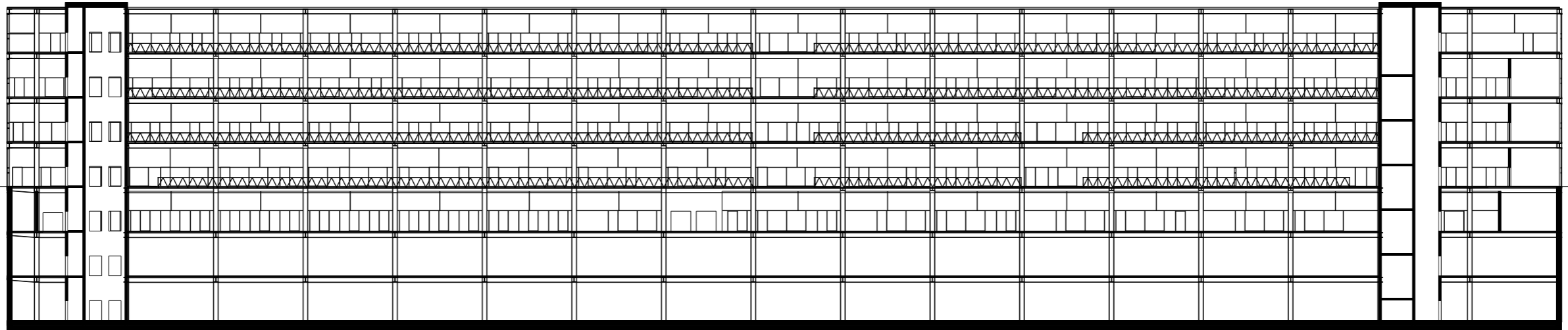

Interior Facade North

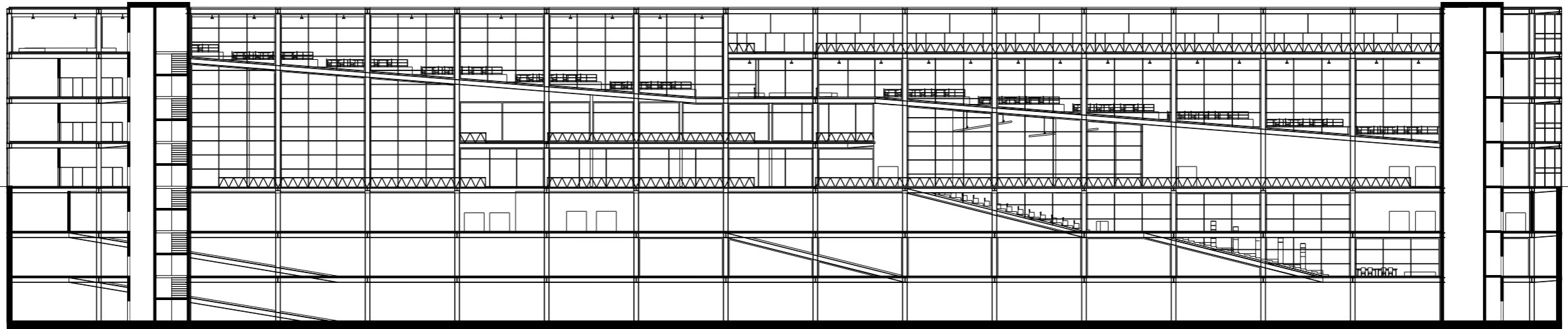

Interior Facade South

|  
0

|  
20m



**Section**

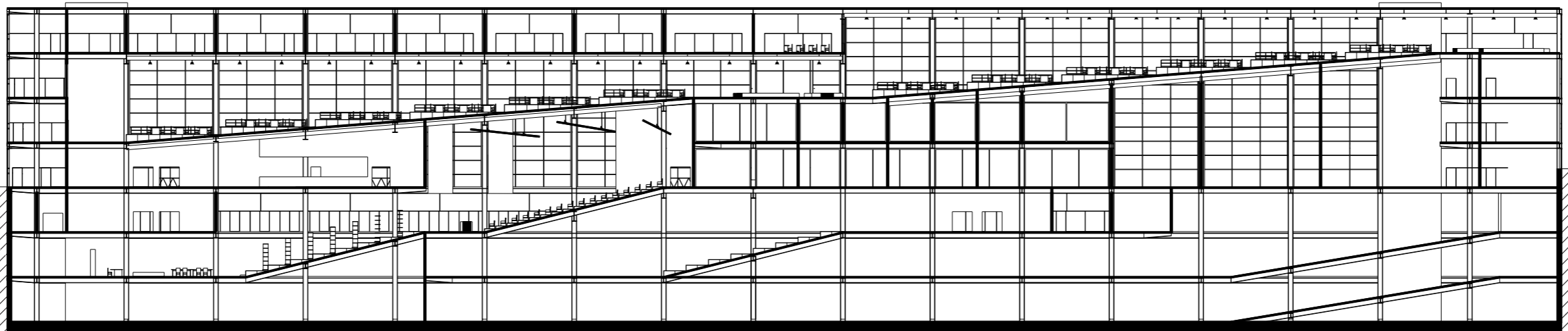
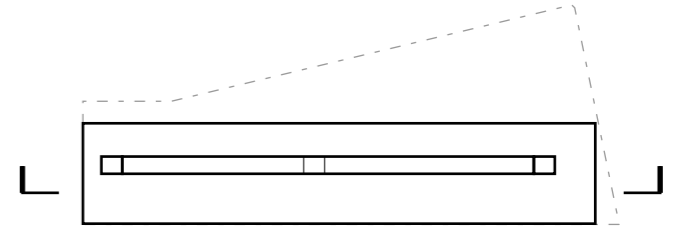

0

20m

Section Perspective

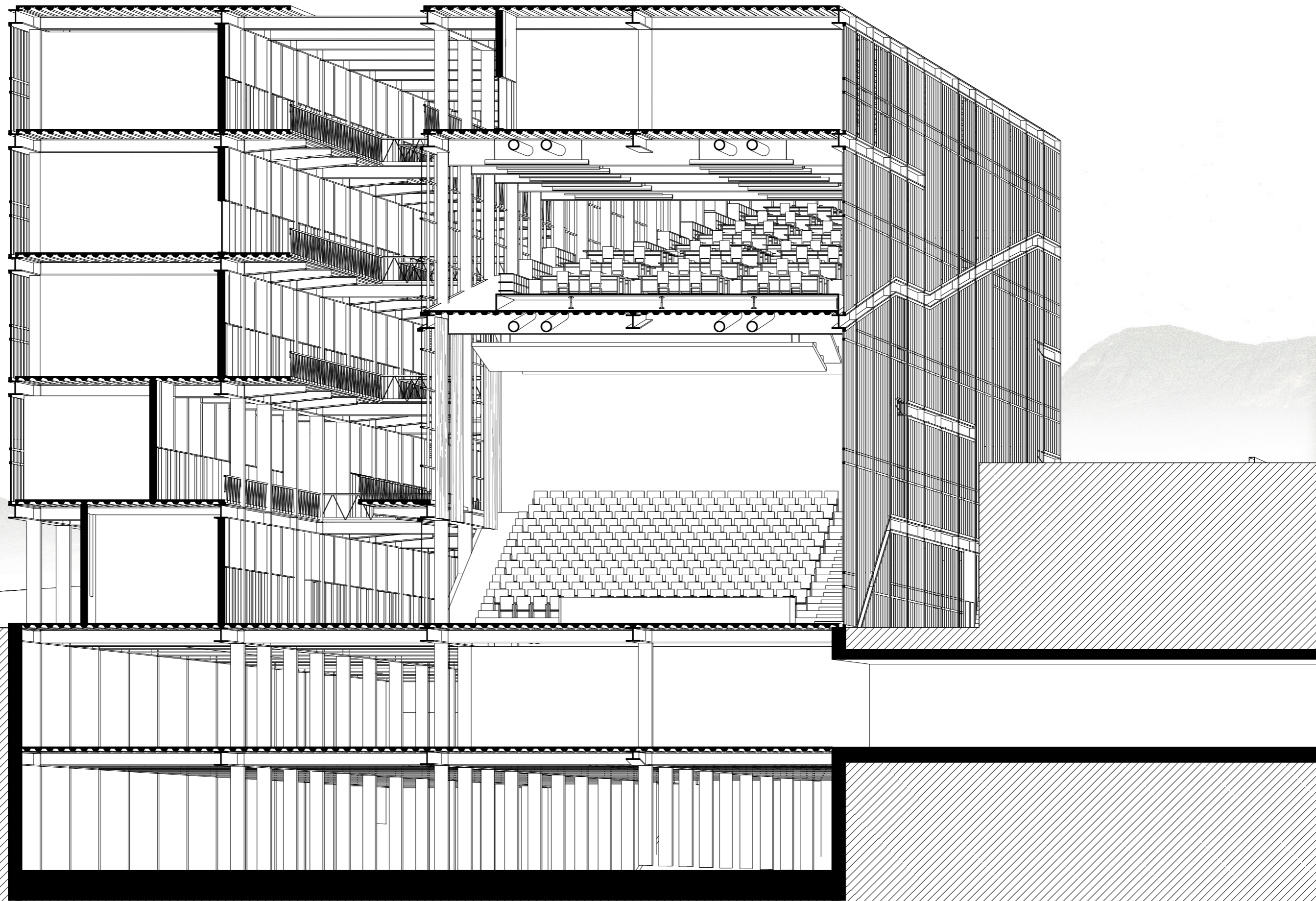







Atrium





Auditorium





# Appendix



1. Surrounding Context - Macro



## 2. Surrounding Context - Meso

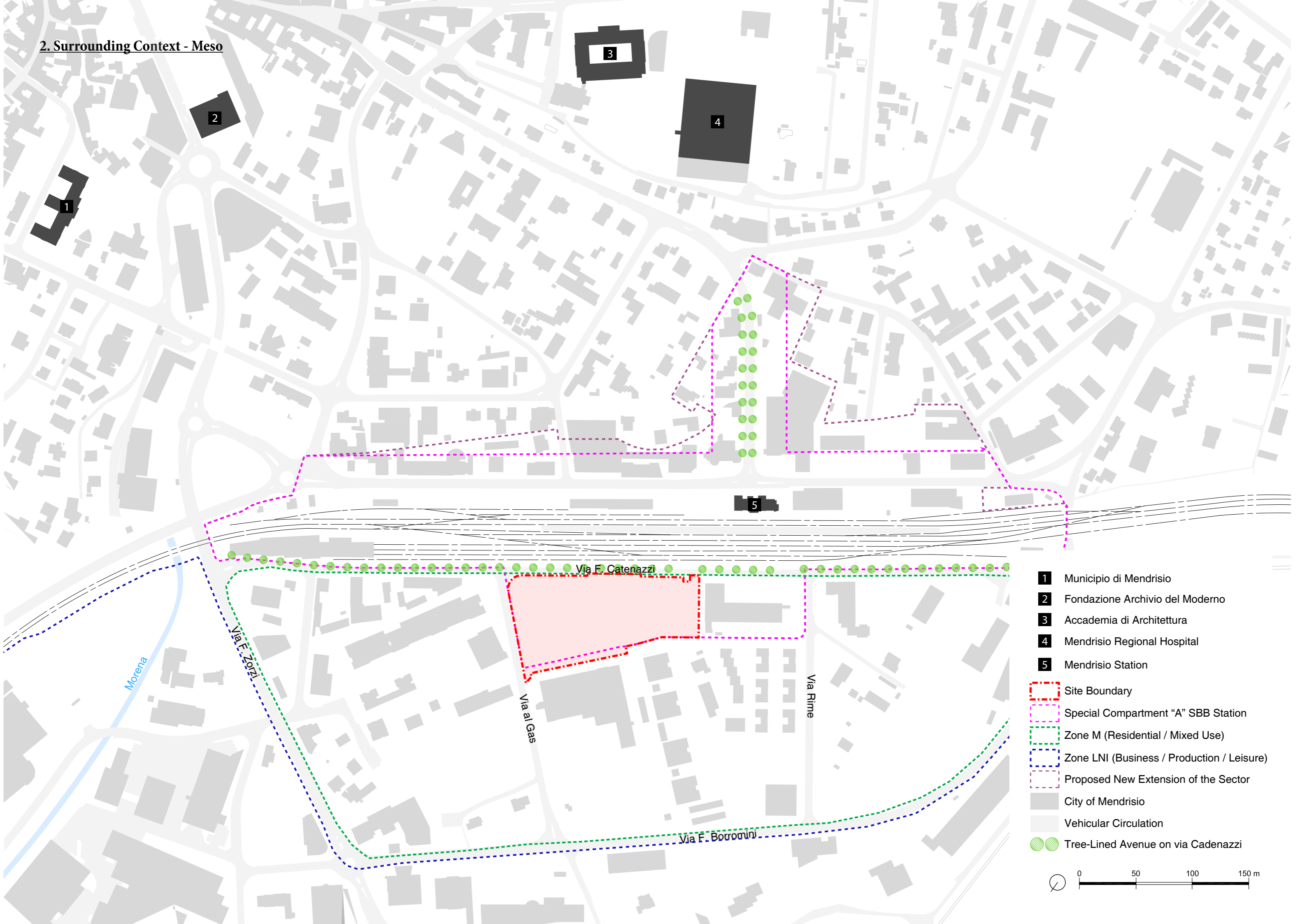

- 1** Municipio di Mendrisio
- 2** Fondazione Archivio del Moderno
- 3** Accademia di Architettura
- 4** Mendrisio Regional Hospital
- 5** Mendrisio Station
- Site Boundary
- Special Compartment "A" SBB Station
- Zone M (Residential / Mixed Use)
- Zone LNI (Business / Production / Leisure)
- Proposed New Extension of the Sector
- City of Mendrisio
- Vehicular Circulation
- Tree-Lined Avenue on via Catenazzi

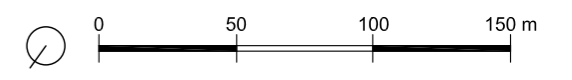



### 3. Existing Underpass

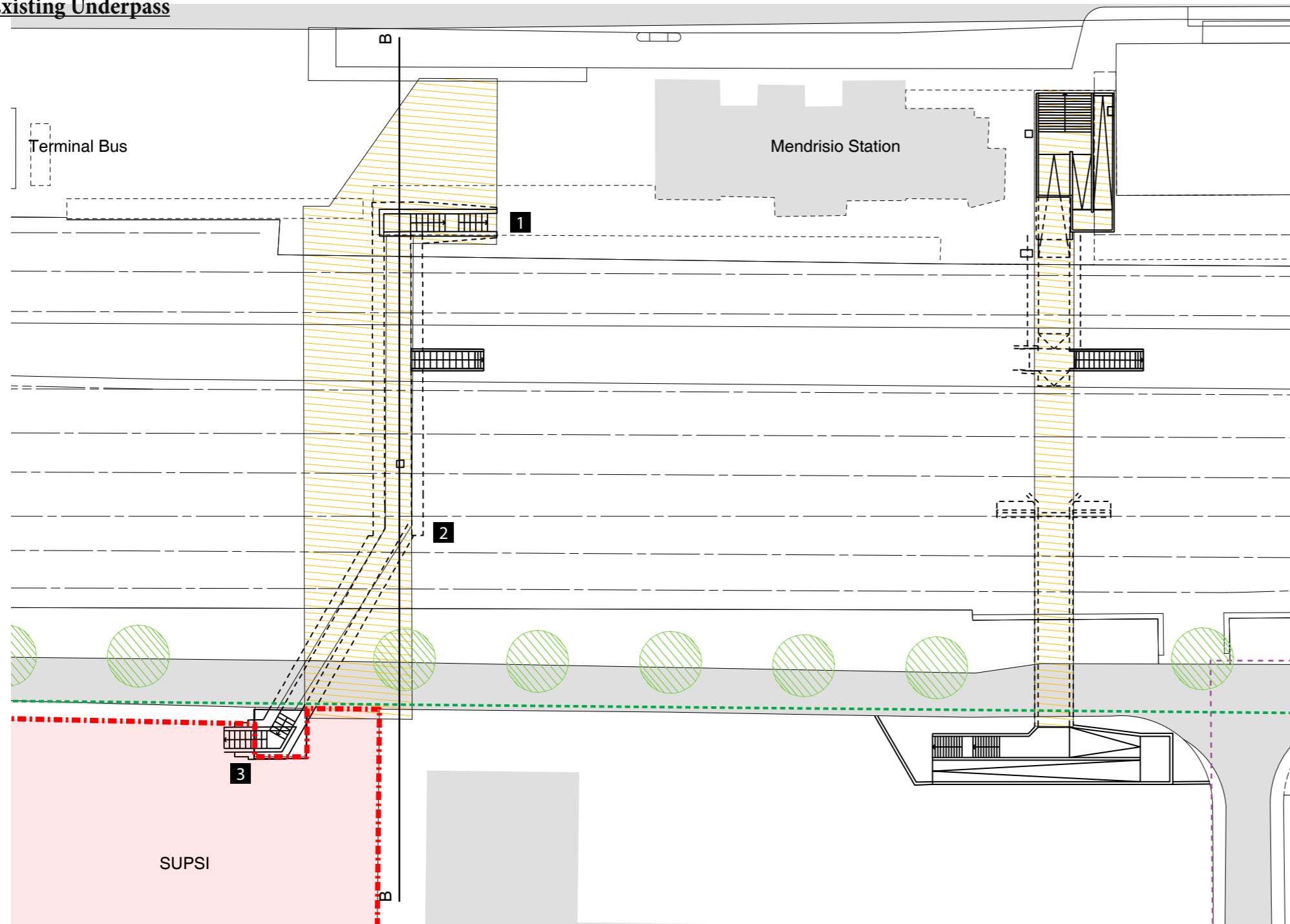

Plan of Underground Passage

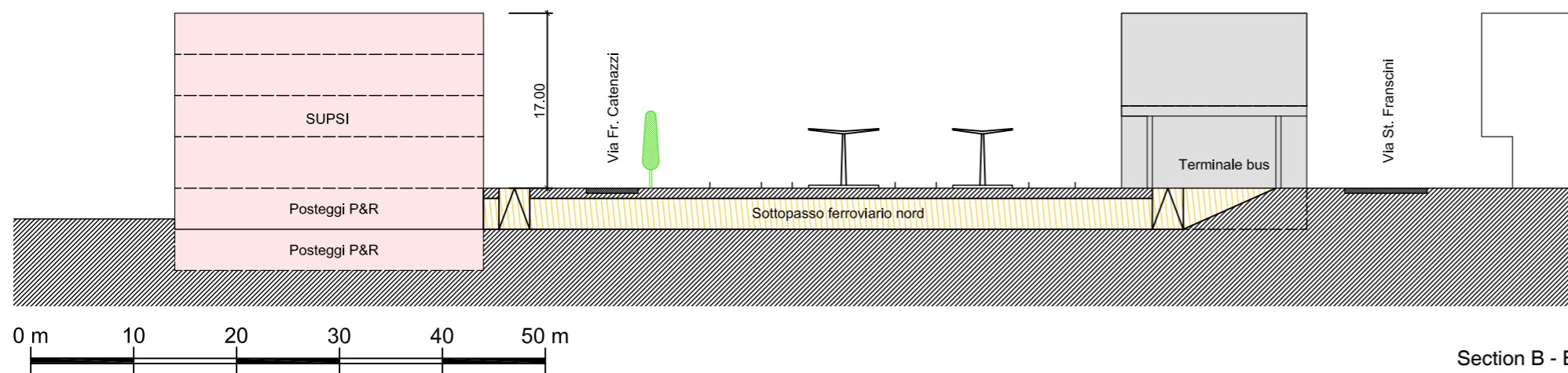

Section B - B



## 4. Areal Chart

### Direction

Staff Office 1 ~ 6	15 ea
Direction Meeting Room	30
Meeting Room	15
Printer Room	15
Logistics Staff Office 1~4	30 ea
Archive	30

### Bachelor Interior Design AI

Atelier 1 ~ 3	180 ea
Theory Classroom	90
Assistance Office	60
Meeting Room	30
Exhibition Space	180
Storage of Teaching Materials	45
Archive	45

### Bachelor Architecture AR

Atelier 1 ~ 3	180 ea
Atelier PAP 1 ~ 3	60 ea
Theory Classroom	120
Modelmaking	90
Storage of Teaching Materials	15
Assistance Office	60
Exhibition Space	90
Archive	45

### Bachelor & Master Conservation and Resoration CR

Lab 1 ~ 2	60 ea
Lab 3	90
Theory Classroom 1~2	90 ea
Theory Classroom 5	45
Theory Classroom (Microscopes)	45
Office 1 ~ 3	30 ea
Archive 1 ~ 3	45 ea

### Bachelor Visual Communication CV

Atelier 1 ~ 3	180 ea
Audio - Video Lab	90
Theory Classroom 1 ~ 3	90 ea
Assistance Office 1 ~ 2	30 ea
Meeting Room	30
Material Rental	15
Archive	45

### Bachelor Civil Engineering GC

Atelier 1 ~ 3	180 ea
Atelier PAP	120
Theory Classroom	90
Office	60
Exhibition Space	90
Archive	45

### Master DCAD

Theory Classroom 1	120
Theory Classroom 2 ~ 3	90 ea
Office 1 ~ 2	15 ea

### Common Bachelor Studies

Theory Classroom 1 ~ 3	60 ea
Theory Classroom 4 ~ 5	90 ea
Auditorium	360
Teacher's Room	60
Material Documentation Center	180

### Continuing Education

Theory Classroom 1	120
Theory Classroom 2	90
Theory Classroom 3	45
Office	15

### Library

Library	360
---------	-----

### Institute of Material and Construction IMC

Management Office	15
Secretary's Office	30
Office 1 ~ 6	30 ea
Printer Room	15
IMC Meeting Room	45

Mechanical Workshop	30
Analysis Laboratory	30
Aggregate Preparation / Sieving Lab	30
AC Room for Specimen Storage	30
AC Room for Lab Tests 1 ~ 2	15 ea
Mechanical Testing Lab	180
Chemical Testing Lab	60
Fresh Concrete Preparation Lab	60
Physical Testing Lab	30
Specimen Preparation Lab	45
Reception of Materials	15
Aging Tests Lab	60
Large Scale Testing Lab	180
Asbestos Analysis Lab	15
Microscopy Lab	30
Binding Agents Test Lab	30
Dynamat 3D Lab	120
Dynamat Lab	240
Carpentry	45
Material Depot	45

Sample Archive	15
File Archive	45
Showers	15

### Applied Sciences for Built Environment ISAAC

Office 1 ~ 4	15 ea
Office 5 ~ 17	30 ea
Office 18 ~ 19	60
Meeting Room 1 ~ 2	15 ea
Meeting Room 3	45

Certification Lab: Material Input	60
Certification Lab: Reception and Shipping	30
Swiss PVMTC Lab: Atrium	30
Swiss PVMTC Lab: Technical Office	45
Certification Lab: Test Visualisation	30
Certification Lab: Warehouse	120
Swiss PVMTC Lab: Warehouse	30
Swiss PVMTC Lab: Darkrooms 1 ~ 2	60 ea
Certification Lab: Steady State	30
Electronics Lab	60
Certification Lab: Electrical Lab	120
Certification Lab: Mechanical Lab	90
Certification Lab: Data Acquisition	45
Certification Lab: Climate Chambers	180
Storehouse	45

Archive	45
Showers	15

### Institute of Earth Sciences IST

Collaboratory Office 1 ~ 10	15 ea
Collaboratory Office 11 ~ 20	30 ea
Meeting Room	45
Printer Room	15

Depot	75
Limnology Depot	45
Photogrammatry & Cartography Lab	30
Chemical Lab	45
Geotechnical Lab	60
Tool Room	45

Library & Archive	45
-------------------	----

### Visual Culture Lab LCV

Institute Management Office	15
Open Space Service Area	90
Office Service Area	30
Research Area Office 1 ~ 2	60
Research Laboratory	45
Meeting Room LCV	30

Archive	45
---------	----

### Mensa

Dining Hall for 200	300
Kitchen Preparation	30
Kitchen Washing	15
Kitchen Cooking	45
Confectionery	15
Kitchen Salad Preparation	15
Kitchen Food Handout	15
Storehouse	45
Cold Storage	30
Cleaning Room	15
Management Office	15
Sorting Office	15
Service Entrance	15
Changing Room	30
Toilet	37.5

### Kindergarten

Wardrobe	30
Classrooms 1 ~ 4	30 ea
Quiet Room	30
Kitchen	15
Management Office	15
Meeting Room	15
Toilet	15

### Common Area

Caretaker's Office	30
Repair Workshop	45
Caretaker Material	15
Changing Rooms / Showers	30 ea
Supervisory Office	15
Medical Room	15
Private Interview Room	15
Cafeteria 1 ~ 2	60 ea
Exhibition	300
IT Office 1 ~ 2	30 ea
Server Room	30
Storage of Consumables	30
Furniture Storage	90
Depot Rooms	120
Showers	30

### Parking

P&R for 400 Cars	5000
------------------	------

.....	Office
————	Research Labs
-----	Archive
————	Public
————	Learning and Teaching
- - - -	Service
- - - -	Exhibition

Total Utility Area: 19,048 sqm

Site Area: 11,359 sqm



**5 - 1. Demolished Buildings on Site**



Riri SA







(Ti-Press / Bianchi)



**MENDRISIOTTO**

09.12.2020 - 17:05 | bed 138

Update: 17:22

## Mendrisio, a cycle-pedestrian street for the station sector

Inauguration of the new via Catenazzi, trait d'union between the intermodal node, the Ffs station and the (almost ready) Supsi campus



**7. Accademia di Architettura**





**8. Previous Education Spaces in Trevano Campus**



**Atelier of Conservazione**



**IMC and IST**



**Press Machine in IMC**



**Machinery for Double Height Room in ISAAC**